



WINDOW TECHNOLOGY
DOOR TECHNOLOGY
AUTOMATIC ENTRANCE SYSTEMS
BUILDING MANAGEMENT SYSTEMS

**DOUBLY
SECURE**

THE
ORIGINAL
BY THE
INVENTOR



GU-SECURITY AUTOMATIC-DR

The new locking type GU-SECURITY Automatic-DR
combines security with ease of use.

Securing technology for you



GU-SECURY multi-point lock

The success story of an original

The new lock by the inventor of the automatic multi-point locking.

1979

GU-SECURY R
multi-point lock



GU-SECURY SB
multi-point lock



GU-SECURY SH
multi-point lock



GU-SECURY Automatic
multi-point lock



GU-SECURY Automatic4
multi-point lock



GU-SECURY MR
multi-point lock



GU-SECURY DR
multi-point lock



GU-SECURY AB
multi-point lock



40 years

Multi-point locking innovation

THE ORIGINAL
BY THE INVENTOR



DOUBLY
SECURE



2019

GU-SECURITY Automatic-DR
multi-point lock

New: Automatic double bolt locking type
– combination of Automatic latchbolt and
hook bolt – all locking elements extend
automatically when the door is closed.



GU-SECURY Automatic-DR

Self-locking comfort

"Did you lock the door dear?"
"It's automatic, darling."

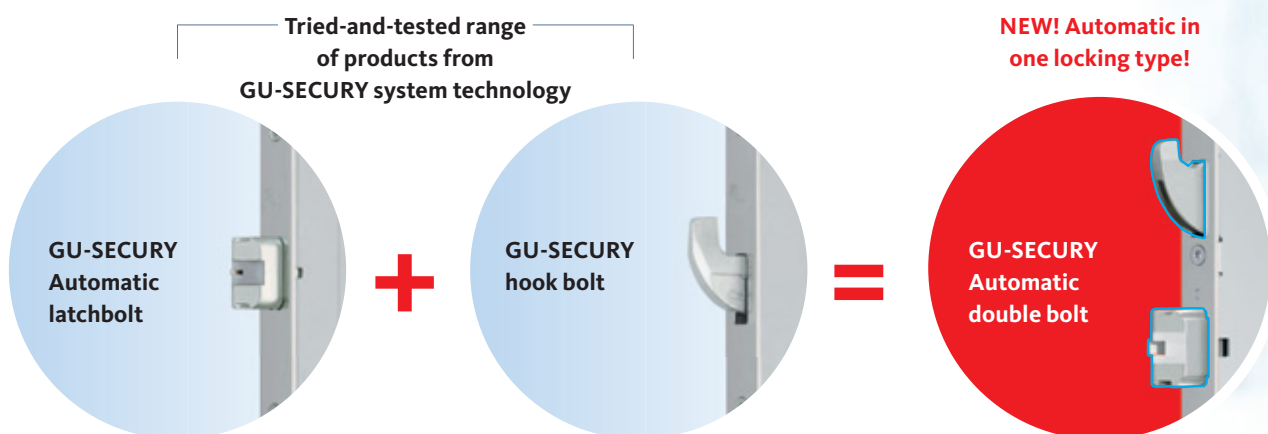

The new Automatic double bolt locking type is a further development of the proven GU-SECURY system technology range – the modular faceplate length concept: the new multi-point lock combines an Automatic latchbolt with a hook bolt – which lock automatically in tandem.

Automatically locked twice – doubly secure!

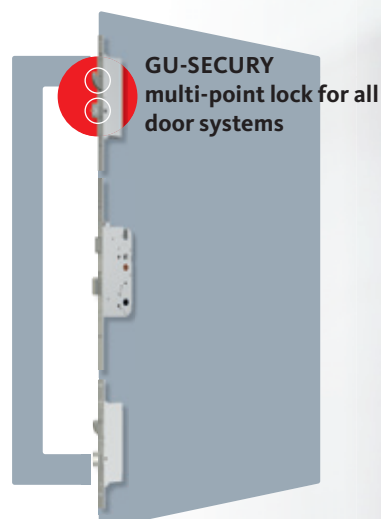



**DOUBLY
SECURE**

THE
ORIGINAL
BY THE
INVENTOR

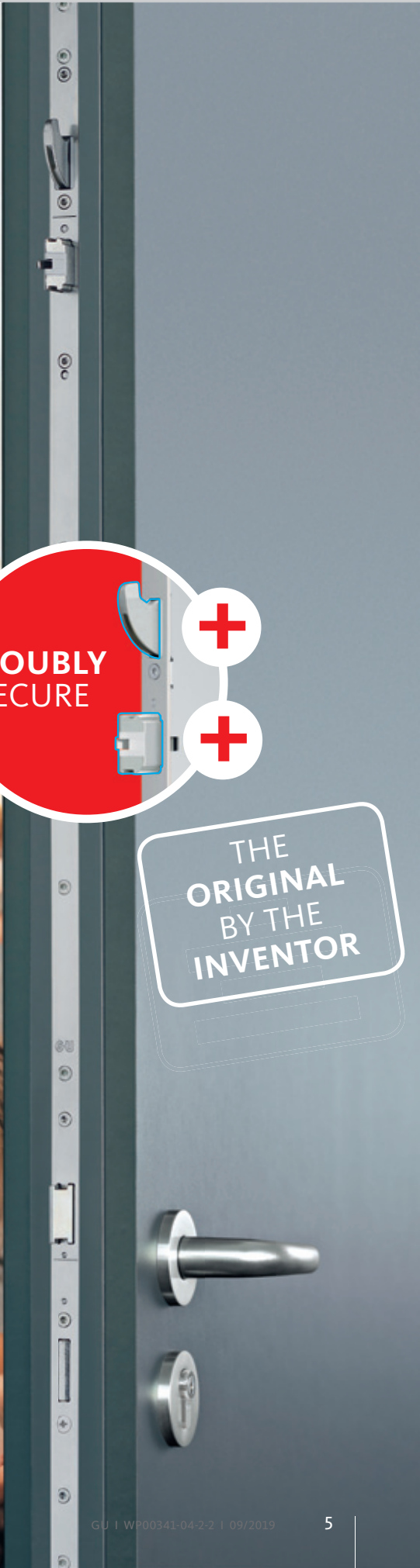

GU-SECURITY Automatic-DR

The technology

Hook bolt

Automatic latchbolt

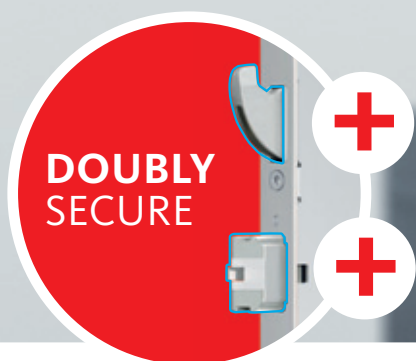

More security

Automatically secure.

Automatic latchbolt

The mechanical self-locking locking systems by Gretsch-Unitas dispense with the need to actuate the central deadbolt by key. Simply allow the door to shut, the Automatic latchbolts automatically throw and the door is locked, no further action is required. Additional locking with the key is only required if the lever handle needs to be blocked from the inside, i.e. when used as a childproof safety device.

Doubly secure.

Hook bolt

Parallel to the self-locking latchbolts, two additional self-locking hook bolts engage in the frame parts and move into the top of the frame, which prevents would-be burglars from levering out the door and also guarantees outstanding functional reliability when lowering the door. All locking elements are secured against being forced back. The system provides you with a multi-point locking system which is saw-through proof and hooks in behind the striker.

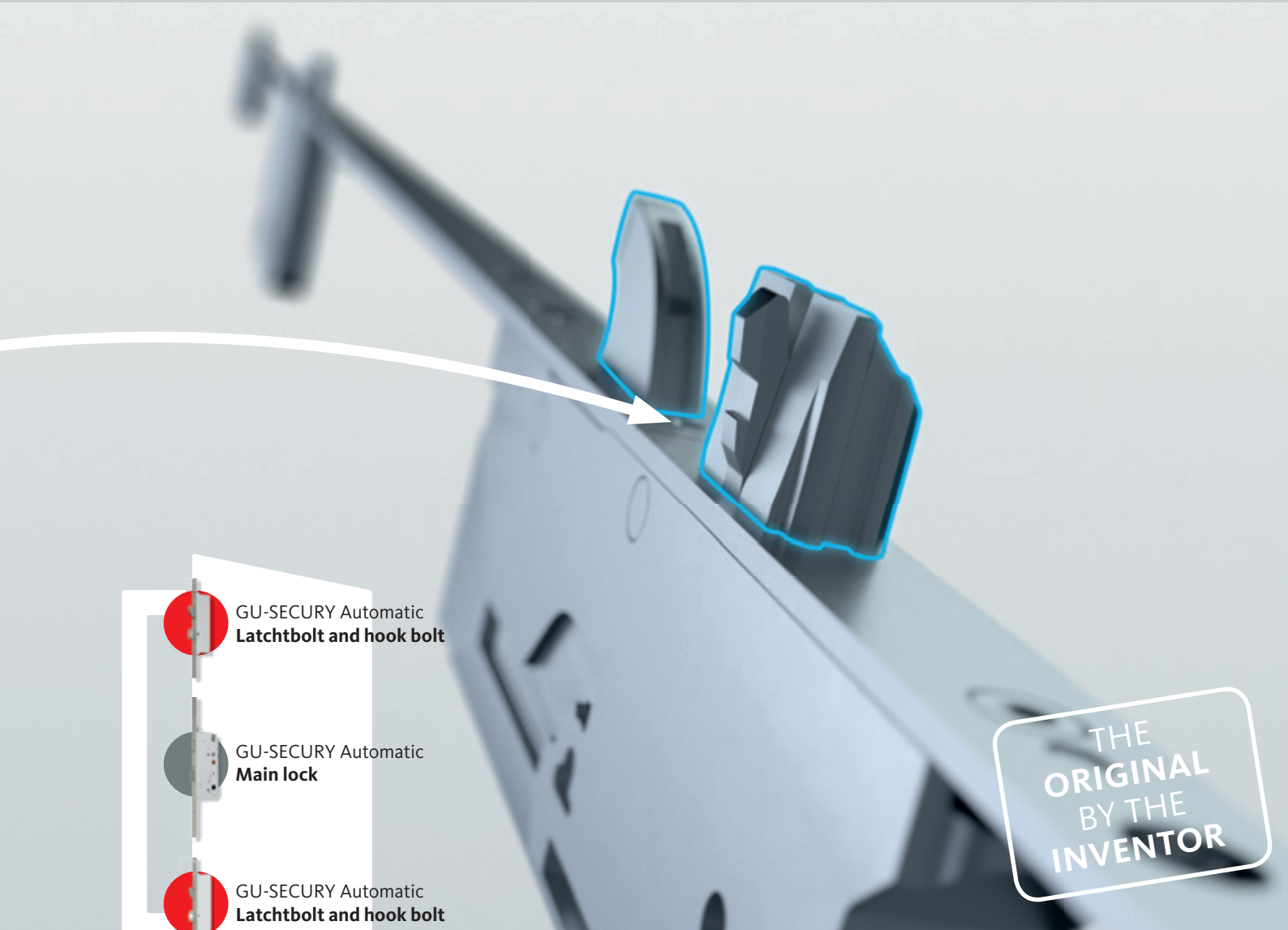

GU-SECURY Automatic
Latchbolt and hook bolt



GU-SECURY Automatic
Main lock



GU-SECURY Automatic
Latchbolt and hook bolt

THE ORIGINAL
BY THE
INVENTOR

Tested and certified.

The original by the inventor

- Approved to prEN 15685 (locks and hardware – multi-point locks and corresponding latch&deadbolt strikers – requirements and test methods)
- Compatible with RC 2, RC 3 and RC 4 in accordance with EN 1627
- VdS Class C approved in accordance with VdS 2201 (in preparation)



GU-SECURY Automatic-DR

Convenience

Simply allow the door to fall shut

Door locks automatically

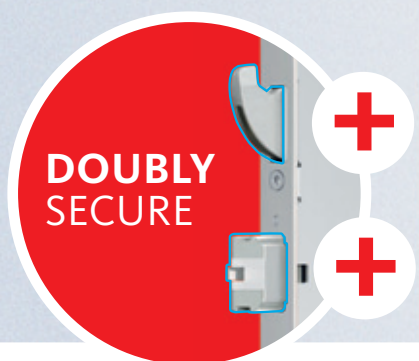

More convenience

Automatically locking

Premium quality by the inventor

The lock ensures effortless and reliable locking and unlocking of house entrance doors and apartment doors. When the door is pulled shut, the Automatic latchbolts are immediately triggered automatically and activate the hook bolts mechanically. The hook bolts now engage with the frame parts, irrespective of the position of the Automatic latchbolts. When the lever handle is operated to open the door, all locking elements are retracted once again.

Comfortably experience security

Solutions for barrier-free doors

Automatic openers and Automatic openers servo are used to facilitate convenient or even barrier-free opening of doors. With the A-opener servo, the opening motor is activated and the locking elements are retracted if the key is turned slightly or the lever handle is lightly tapped. To provide additional security and as an alternative to door chain or door viewer, the door arrester device of the safe-T-catch prevents the door from being opened by more than a certain amount. With the GU-SECURY Automatic-DR system with daytime release function, the locking elements can be mechanically locked by the authorised user in the withdrawn position, if required. The door can therefore be opened from the outside without a key.

Fingerprint scanner
 Wall-mounted push-button
 Transponder
 Card reader



GU-SECURITY Automatic-DR
 Multi-point lock for all door systems



THE ORIGINAL
 BY THE INVENTOR

With all options

Ease of use due to access control systems

The GU-SECURITY Automatic-DR is compatible with BKS access control systems, such as the house intercom, wall-mounted push-button, card reader, transponder, fingerprint scanner, wireless transponder, that allow only authorised persons to pass through the door.



More benefits: Premium quality by the inventor

For planners/architects, fabricators and home owners

Double security

When the door is pulled shut, the Automatic latchbolts are immediately triggered automatically and activate the hook bolts. The hook bolts now engage with the frame parts, irrespective of the position of the Automatic latchbolts. The hook bolts move into the top of the frame, which prevents would-be burglars from levering out the door, and also guarantees outstanding functional reliability when lowering the door. The locking elements are secured against being forced back. Additional locking with the key is only required if the lever handle needs to be blocked from the inside, i.e. when used as a childproof safety device.

Very easy operation

The lock ensures effortless and reliable locking and unlocking. The Automatic-DR mechanical self-locking exit device dispenses with the need for manual locking with a key. The Automatic latchbolt is combined with a solid hook bolt and both are thrown automatically when the door engages in the lock.

Certified security

- prEN 15685 approval (locks and hardware – multi-point locks and corresponding latch&deadbolt strikers – requirements and test methods)
- Compatible with RC 2, RC 3 and RC 4 in accordance with EN 1627
- VdS Class C approved in accordance with VdS 2201 (in preparation)

Accessibility

Automatic openers and Automatic openers servo are used to facilitate convenient or even barrier-free opening of doors. With the A-opener servo, the opening motor is activated and the Automatic latchbolts are retracted if the key is turned slightly or the lever handle is lightly tapped.

Daytime release function for e.g. public traffic

With the GU-SECURITY Automatic-DR system with daytime release function, the locking elements can be mechanically locked by the authorised user in the withdrawn position, if required. The door can therefore be opened from the outside without a key.

Safe-T-catch for door arrester device

To provide additional security and as an alternative to door chain or door viewer, the door arrester device of the safe-T-catch prevents the door from being opened by more than a certain amount. It is easy and convenient to operate via the turn. This version is particularly suitable for apartment entrance doors and house entrance doors in one-family houses.

THE ORIGINAL BY THE INVENTOR

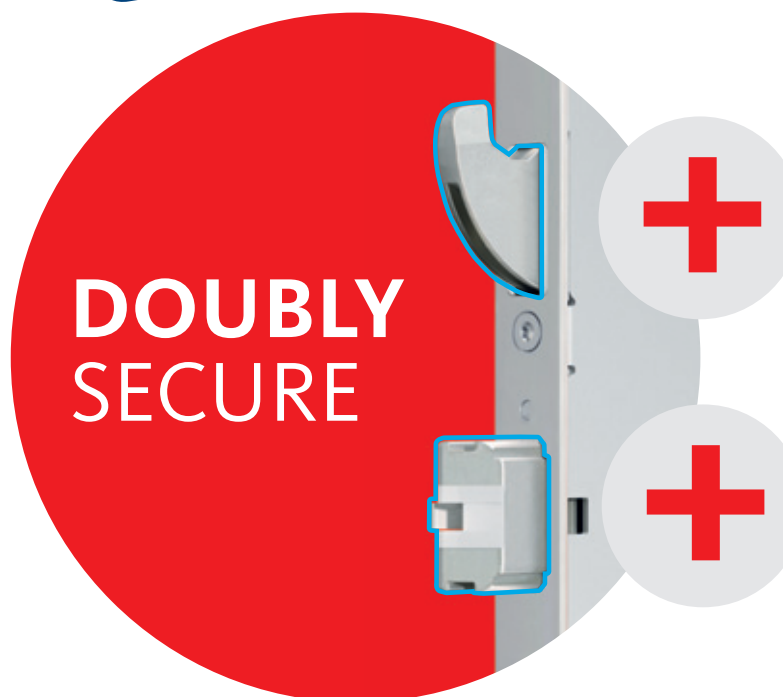

GU house entrance door concept

The GU-SECURITY Automatic-DR is compatible with the SECUREconnect power and data transmission units and can therefore be easily integrated into the GU house entrance door package. Biometric fingerprint detection or the individual access code permit convenient access.

Compatible with BKS access control systems

The GU-SECURITY Automatic-DR is compatible with BKS access control systems, such as the house intercom, wall-mounted push-button, card reader, transponder, fingerprint scanner, wireless transponder, that allow only authorised persons to pass through the door. The fire-retardant variant is suitable for fire protection doors according to DIN 4102 in combination with BKS door hardware for fire rated doors according to EN 1634.

A lock for all house entrance door profiles

The lock is suitable for 1 and 2-leaf house entrance doors and apartment doors made of timber, PVC, metal and other material combinations.



GU-SECURITY Automatic-DR – 1750 mm

Square faceplate ends, hole distance 92 mm

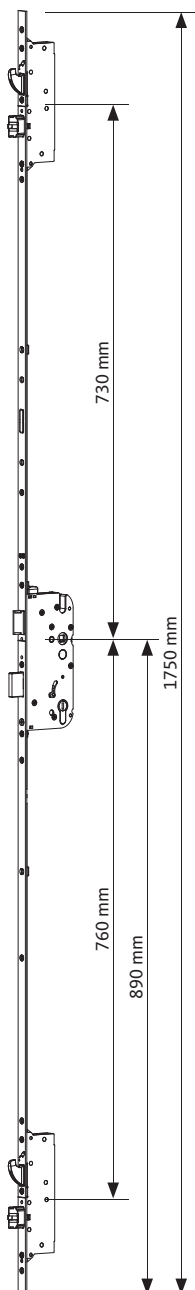

Equipment

Main lock		Additional lock		Faceplate end		Hole distance	
Latch	Deadbolt	Automatic double bolt		Square	Round	92 mm	72 mm
■	■	■		■	-	■	-

Door-leaf rebate height 1750-2285 mm, marking notch 890 mm (variable handle height)

Backset [mm]	Faceplate [mm]	Follower [mm]	PU	Order number
65	U 24 x 6	8	2	6-40470-14-0-1
	16	8	5	6-40470-12-0-1
55	20	10	5	6-40470-40-0-1
	16	10	5	6-40470-38-0-1
	U 24 x 6	8	2	6-40470-42-0-1
	20	8	5	6-40470-39-0-1
	16	8	5	6-40470-37-0-1
50	U 24 x 6	10	2	6-40470-36-0-1
	20	10	5	6-40470-09-0-1
	16	10	5	6-40470-34-0-1
	U 24 x 6	8	2	6-40470-35-0-1
	U 24 x 6	8	2	6-40470-35-0-8
	16	8	5	6-40470-33-0-1
45	U 24 x 6	10	2	6-40470-21-0-1
	20	10	5	6-40470-32-0-1
	16	10	5	6-40470-07-0-1
	U 24 x 6	8	2	6-40470-08-0-1
	U 24 x 6	8	2	6-40470-08-0-8
	24	8	2	6-40470-41-0-8
	20	8	5	6-40470-31-0-1
	16	8	5	6-40470-06-0-1
	40	20	10	5
16		10	5	6-40470-19-0-1
U 24 x 6		8	2	6-40470-05-0-1
U 24 x 6		8	2	6-40470-05-0-8
24		8	5	6-40470-29-0-1
24		8	2	6-40470-29-0-8
20		8	5	6-40470-27-0-1
16		8	5	6-40470-04-0-1
35	16	10	5	6-40470-16-0-1
	U 24 x 6	8	2	6-40470-03-0-1
	U 24 x 6	8	2	6-40470-03-0-8
	24	8	5	6-40470-02-0-1
	24	8	2	6-40470-02-0-8
	16	8	5	6-40470-01-0-1
33	U 24 x 6	8	2	6-40470-24-0-1
	U 24 x 6	8	2	6-40470-24-0-8
	24	8	5	6-40470-22-0-1
	24	8	2	6-40470-22-0-8

Colour: 1 = ferGUard*silver, 8 = satin stainless steel

GU-SECURY Automatic-DR – 1750 mm

Round faceplate ends, hole distance 92 mm

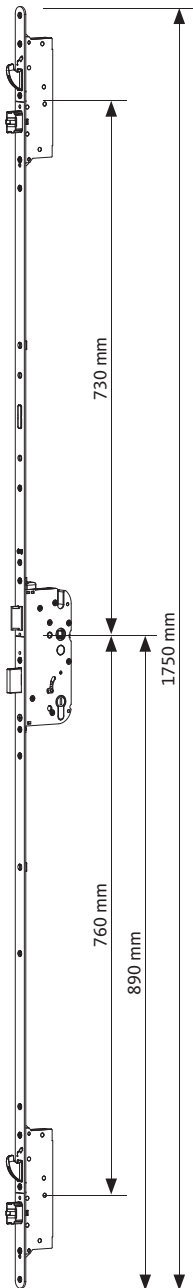

Equipment

Main lock		Additional lock	Faceplate end		Hole distance	
Latch	Deadbolt	Automatic double bolt	Square	Round	92 mm	72 mm
■	■	■	-	■	■	-

Door-leaf rebate height 1750-2285 mm, marking notch 890 mm (variable handle height)

Backset [mm]	Faceplate [mm]	Follower [mm]	PU	Order number
80	20	10	2	6-40470-15-0-1
65	20	10	5	6-40470-13-0-1
55	20	10	5	6-40470-11-0-1
50	24	10	5	6-40470-10-0-1

Colour: 1 = ferGUard*silver

GU-SECURY Automatic-DR – 1750 mm

Round faceplate ends, hole distance 72 mm – for DIN frames

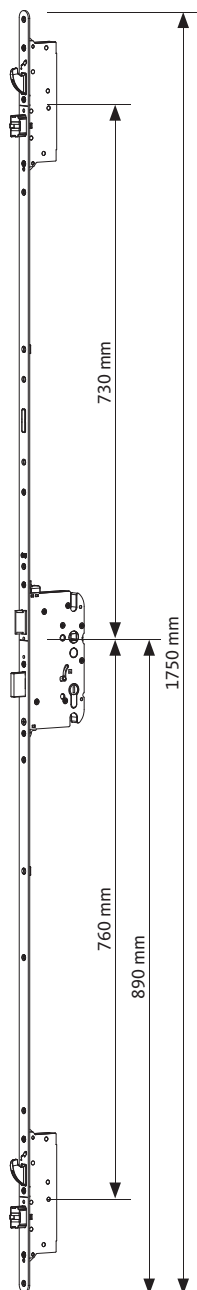

Equipment

Main lock		Additional lock	Faceplate end		Hole distance	
Latch	Deadbolt	Automatic double bolt	Square	Round	92 mm	72 mm
■	■	■	-	■	-	■

Door-leaf rebate height 1750-2285 mm, marking notch 890 mm (variable handle height)

Backset [mm]	Faceplate [mm]	Follower [mm]	PU	Order number
80	20	8	2	6-40367-05-0-1
65	20	8	5	6-40367-04-0-1
55	20	8	5	6-40367-03-0-1

Colour: 1 = ferGUard*silver

GU-SECURY Automatic-DR – 1750 mm



GU-SECURY safe-T-catch set (for multi-point lock)
for timber, PVC and metal doors

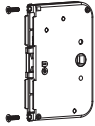

GU-SECURY safe-T-catch set (for multi-point locks) for doors made of timber, PVC and metal – 8 mm safe-T-catch projection

Designation	Backset [mm]	Follower [mm]	PU	Order number
Safe-T-catch set	65	8	5	K-20085-65-0-1
	55	8	5	K-20085-55-0-1
	50	8	5	K-20085-50-0-1
	45	8	5	K-20085-45-0-1
	40	8	5	K-20085-40-0-1
	35	8	5	K-20085-35-0-1
	33	8	5	K-20085-33-0-1

Colour: 1 = ferGUard*silver

Scope of delivery: 1 x safe-T-catch lock, 1 x bag with 2 self-tapping screws, 1 x assembly instructions
Optional safe-T-catch

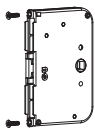

GU-SECURY safe-T-catch set (for multi-point locks) for doors made of timber, PVC and metal – 11 mm safe-T-catch projection

Designation	Backset [mm]	Follower [mm]	PU	Order number
Safe-T-catch set	80	8	5	K-20086-80-0-1
	65	8	5	K-20086-65-0-1
	55	8	5	K-20086-55-0-1
	50	8	5	K-20086-50-0-1
	45	8	5	K-20086-45-0-1
	40	8	5	K-20086-40-0-1
	35	8	5	K-20086-35-0-1
	33	8	5	K-20086-33-0-1

Colour: 1 = ferGUard*silver

Scope of delivery: 1 x safe-T-catch lock, 1 x bag with 2 self-tapping screws, 1 x assembly instructions
Optional safe-T-catch

GU-SECURY Automatic-DR – 1750 mm

Extensions (for multi-point lock) for timber, PVC and metal doors

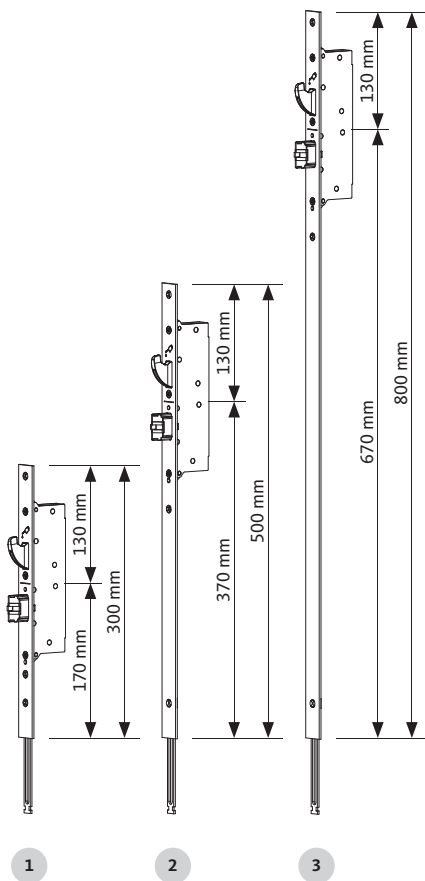
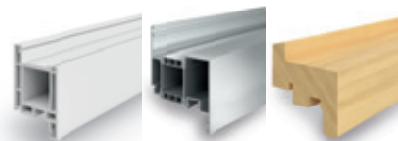

Extensions (for multi-point lock) for timber, PVC and metal doors

Designation	Faceplate [mm]	Faceplate end	PU	Order number
1 Extension with Automatic-DR for locking position +300 mm	U 24 x 6	square	5	6-40487-15-0-1 6-40487-15-0-8
	24	square	5	6-40487-12-0-1 6-40487-12-0-8
	20	round at bottom/at top	5	6-40487-05-0-1
	various	–	–	on request
2 Extension with Automatic-DR for locking position +500 mm	U 24 x 6	square	5	6-40488-15-0-1 6-40488-15-0-8
	24	square	5	6-40488-12-0-1 6-40488-12-0-8
	24	round at bottom/at top	5	6-40488-11-0-1 6-40488-11-0-8
	20	square	5	6-40488-06-0-1 6-40488-06-0-8
	20	round at bottom/at top	5	6-40488-05-0-1
	16	square	5	6-40488-01-0-1
3 Extension with Automatic-DR For locking position +800 mm	U 24 x 6	square	5	6-40489-15-0-1 6-40489-15-0-8
	24	square	5	6-40489-12-0-1 6-40489-12-0-8
	24	round at bottom/at top	5	6-40489-11-0-1 6-40489-11-0-8
	20	round at bottom/at top	5	6-40489-05-0-1
	16	square	5	6-40489-01-0-1
	various	–	–	on request

Colour: 1 = ferGUard*silver, 8 = satin stainless steel

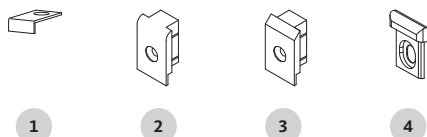

Clamping part/end piece for timber, PVC and metal doors

Designation	Faceplate [mm]	Shape	PU	Order number
1 Clamping part for flat faceplate	–	–	100	9-29498-00-0-1
2 End piece for flat faceplate	16	round	100	9-35946-01-0-1
	20	round	100	9-35946-02-0-1
3 End piece for flat faceplate	20	bevelled	100	9-35946-03-0-1
	24	bevelled	100	9-35946-04-0-1
4 End piece for U-faceplate	U 24 x 6	–	200	9-39909-01-0-6

Colour: 1 = ferGUard*silver, 6 = black coloured, RAL 9005

GU-SECURY Automatic-DR – 1750 mm

Extension piece (for multi-point lock) for timber, PVC and metal doors

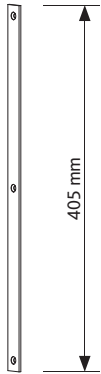

1

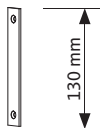

2

Extension piece (for multi-point lock) for timber, PVC and metal doors

Designation	Faceplate [mm]	Faceplate end	PU	Order number
1 Top extension piece L = 405 mm For SECURY multi-point lock	U 30 x 10	square	10	9-48687-23-0-1
	U 24 x 6	square	10	9-48687-15-0-1 9-48687-15-0-8
	24	square	10	9-48687-12-0-1 9-48687-12-0-8
	24	round at bottom/at top	10	9-48687-11-0-1 9-48687-11-0-8
	24	round at bottom	10	9-48687-47-0-1 9-48687-47-0-8
	20	square	10	9-48687-06-0-1 9-48687-06-0-8
	20	round at bottom/at top	10	9-48687-05-0-1 9-48687-05-0-8
	20	round at bottom	10	9-48687-46-0-1 9-48687-46-0-8
	16	square	10	9-48687-01-0-1 9-48687-01-0-8
	16	round at bottom/at top	10	9-48687-45-0-1 9-48687-45-0-8
	various	-	-	on request
	2 Bottom extension piece L = 130 mm For SECURY multi-point lock	U 30 x 10	square	10
U 24 x 6		square	10	9-48686-15-0-1 9-48686-15-0-8
24		square	10	9-48686-12-0-1 9-48686-12-0-8
24		round at bottom/at top	10	9-48686-11-0-1 9-48686-11-0-8
24		round at bottom	10	9-48686-47-0-1 9-48686-47-0-8
20		square	10	9-48686-06-0-1 9-48686-06-0-8
20		round at bottom/at top	10	9-48686-05-0-1 9-48686-05-0-8
20		round at bottom	10	9-48686-46-0-1 9-48686-46-0-8
16		square	10	9-48686-01-0-1 9-48686-01-0-8
16		round at bottom/at top	10	9-48686-45-0-1 9-48686-45-0-8
various		-	-	on request

Colour: 1 = ferGUard*silver, 8 = satin stainless steel

GU-SECURITY Automatic-DR – 1750 mm

One-piece strikers/L&D strikers/Strikers/Safe-T-catch strikers/Hinge-side locking devices for PVC profile systems



PVC profile system	GU-SECURITY Automatic-DR multi-point lock					One-piece striker adjustable		
	Leaf profile	Frame profile	Installation drawing	Backset/Distance	Face-plate [mm]	With interchangeable latch piece		
Dimension L [mm]						1750		
Packing unit						PU = 5		
Aluplast								
Aluplast Ideal 4000	140033	140003	0-43690	45/92	16	6-40022-DM-L-1 6-40022-DM-R-1	U 30 x 6	
Aluplast Ideal 7000	140033	170005	0-43690	45/92	16	6-40022-CA-L-1 6-40022-CA-R-1	U 30 x 8	
Aluplast Ideal 8000	180032	180003	0-43690	40/92	16	6-40022-CA-L-1 6-40022-CA-R-1	U 30 x 8	
Aluplast energeto 4000	140033	140003	0-43690	45/92	16	6-40022-DM-L-1 6-40022-DM-R-1	U 30 x 6	
Aluplast energeto 7000	140033	170005	0-43690	45/92	16	6-40022-CA-L-1 6-40022-CA-R-1	U 30 x 8	
Aluplast energeto 8000	180032	180003	0-43690	40/92	16	6-40022-CA-L-1 6-40022-CA-R-1	U 30 x 8	
Deceuninck (Inotiv)								
Deceuninck zen dow	-	3001	0-43690	35/92	16	6-40022-AE-L-1 6-40022-AE-R-1	U 30 x 8	
Deceuninck zen dow neo	5049 (5512)	5002	0-43690	40/92	16	6-40022-AE-L-1 6-40022-AE-R-1	U 30 x 8	
Deceuninck Arcade	HA 7140	LH 710	0-43690	45/92	16	6-40022-DP-L-1 6-40022-DP-R-1	U 30 x 6	
Deceuninck Prestige	Z 276	L 176	0-43690	35/92	16	6-40022-DP-L-1 6-40022-DP-R-1	U 30 x 6	
Deceuninck Eforte	HLE 484	LLE 684	0-43690	45/92	16	6-40022-DP-L-1 6-40022-DP-R-1	U 30 x 6	
Deceuninck Elegante	HP 4-5115	LP2/C-5111	0-43690	45/92	16	6-40022-FZ-L-1 6-40022-FZ-R-1	U 30 x 8	
Gealan								
Gealan S 3000	3076 (3042)	3008 (3011)	0-43690	45/92	16	6-40022-AG-L-1 6-40022-AG-R-1	U 30 x 8	
Gealan S 7000 IQ	7076	7011	0-43690	45/92	16	6-40022-AT-L-1 6-40022-AT-R-1	U 35 x 8	
Gealan S 7000 IQ Plus	7076	5010	0-43690	45/92	16	6-40022-AT-L-1 6-40022-AT-R-1	U 35 x 8	
Gealan S 8000 IQ	8076	8011	0-43690	45/92	16	6-40022-CC-L-1 6-40022-CC-R-1	U 35 x 8	
Gealan S 9000	6025	6003 (6002)	0-43690	45/92	16	6-40022-CC-L-1 6-40022-CC-R-1	U 35 x 8	









GU-SECURY Automatic-DR – 1750 mm



One-piece strikers/L&D strikers/Strikers/Safe-T-catch strikers/Hinge-side locking devices for PVC profile systems



L&D striker	Striker adjustable	Safe-T-catch striker	Hinge-side locking device		SECUREconnect	
			For safe-T-catch	Frame Wedged keep	Leaf Drill-in cam Length = 54 mm	Faceplate/leaf
216.5	181	227	120	115	350	350
PU = 5	PU = 20	PU = 5	PU = 6	PU = 6	PU = 1	PU = 1
						
6-37654-2U-L-1 6-37654-2U-R-1	6-40007-DM-0-1	6-28586-2U-L-1 6-28586-2U-R-1	6-28961-2U-0-1	6-28985-06-0-1	9-45903-09-0-1	6-35513-2U-L-1 6-35513-2U-R-1
6-37675-5K-L-1 6-37675-5K-R-1	6-40007-CA-0-1	6-31632-5K-L-1 6-31632-5K-R-1	6-28961-5K-0-1 ^[2]	6-28985-06-0-1	9-45903-09-0-1	6-35513-5K-L-1 6-35513-5K-R-1
6-37675-5K-L-1 6-37675-5K-R-1	6-40007-CA-0-1	6-31632-5K-L-1 6-31632-5K-R-1	6-28961-5K-0-1 ^[2]	6-28985-06-0-1	9-45903-09-0-1	6-35513-5K-L-1 6-35513-5K-R-1
6-37654-2U-L-1 6-37654-2U-R-1	6-40007-DM-0-1	6-28586-2U-L-1 6-28586-2U-R-1	6-28961-2U-0-1	6-28985-06-0-1	9-45903-09-0-1	6-35513-2U-L-1 6-35513-2U-R-1
6-37675-5K-L-1 6-37675-5K-R-1	6-40007-CA-0-1	6-31632-5K-L-1 6-31632-5K-R-1	6-28961-5K-0-1 ^[2]	6-28985-06-0-1	9-45903-09-0-1	6-35513-5K-L-1 6-35513-5K-R-1
6-37675-5K-L-1 6-37675-5K-R-1	6-40007-CA-0-1	6-31632-5K-L-1 6-31632-5K-R-1	6-28961-5K-0-1 ^[2]	6-28985-06-0-1	9-45903-09-0-1	6-35513-5K-L-1 6-35513-5K-R-1
6-37675-34-L-1 6-37675-34-R-1	6-40007-AE-0-1	6-31632-34-L-1 6-31632-34-R-1	6-28961-34-0-1	6-28985-06-0-1	9-45903-09-0-1	6-35513-34-L-1 6-35513-34-R-1
6-37675-34-L-1 6-37675-34-R-1	6-40007-AE-0-1	6-31632-34-L-1 6-31632-34-R-1	6-28961-34-0-1	6-28985-06-0-1	9-45903-09-0-1	6-35513-34-L-1 6-35513-34-R-1
6-37654-79-L-1 6-37654-79-R-1	6-40007-DP-0-1	6-28586-79-L-1 6-28586-79-R-1	6-28961-79-0-1	6-28985-06-0-1	9-45903-09-0-1	6-35513-79-L-1 6-35513-79-R-1
6-37654-79-L-1 6-37654-79-R-1	6-40007-DP-0-1	6-28586-79-L-1 6-28586-79-R-1	6-28961-79-0-1	6-28985-06-0-1	9-45903-09-0-1	6-35513-79-L-1 6-35513-79-R-1
6-37654-79-L-1 6-37654-79-R-1	6-40007-DP-0-1	6-28586-79-L-1 6-28586-79-R-1	6-28961-79-0-1	6-28985-06-0-1	9-45903-09-0-1	6-35513-79-L-1 6-35513-79-R-1
6-37675-6J-L-1 6-37675-6J-R-1	6-40007-FZ-0-1	6-31632-6J-L-1 6-31632-6J-R-1	6-28961-6J-0-1	6-28985-06-0-1	9-45903-09-0-1	6-35513-34-L-1 6-35513-34-R-1
6-37675-21-L-1 6-37675-21-R-1	6-40007-AG-0-1	6-31632-21-L-1 6-31632-21-R-1	6-28961-21-0-1	6-28985-06-0-1	9-45903-09-0-1	6-35513-21-L-1 6-35513-21-R-1
6-37558-4P-L-1 6-37558-4P-R-1	6-40007-AT-0-1	6-31632-4P-L-1 6-31632-4P-R-1	6-28961-4P-0-1	6-28985-06-0-1	9-45903-09-0-1	6-35513-4P-L-1 6-35513-4P-R-1
6-37558-4P-L-1 6-37558-4P-R-1	6-40007-AT-0-1	6-31632-4P-L-1 6-31632-4P-R-1	6-28961-4P-0-1	6-28985-06-0-1	9-45903-09-0-1	6-35513-4P-L-1 6-35513-4P-R-1
6-37558-6D-L-1 6-37558-6D-R-1	6-40007-CC-0-1	6-31632-4P-L-1 6-31632-4P-R-1	6-28961-4P-0-1	6-28985-06-0-1	9-45903-09-0-1	6-35513-6D-L-1 6-35513-6D-R-1
6-37558-6D-L-1 6-37558-6D-R-1	6-40007-CC-0-1	6-31632-4P-L-1 6-31632-4P-R-1	6-28961-4P-0-1	6-28985-06-0-1	9-45903-09-0-1	6-35513-6D-L-1 6-35513-6D-R-1

^[2] on request

GU-SECURITY Automatic-DR – 1750 mm

One-piece strikers/L&D strikers/Strikers/Safe-T-catch strikers/Hinge-side locking devices for PVC profile systems









PVC profile system	GU-SECURITY Automatic-DR multi-point lock					One-piece striker adjustable			
	Leaf profile	Frame profile	Installation drawing	Backset/Distance	Face-plate [mm]	With interchangeable latch piece			
Dimension L [mm]						1750			
Packing unit						PU = 5			
Profine KBE									
Profine KBE 76 AD	76204	76102	0-43690	40/92	16	6-40022-AK-L-1 6-40022-AK-R-1	U 35 x 8		
	76206	76102	0-43690	40/92	20	6-40022-FU-L-1 6-40022-FU-R-1	U 35 x 8		
Profine KBE 76 MD	76272 (76279)	76102	0-43690	40/92	16	6-40022-AK-L-1 6-40022-AK-R-1	U 35 x 8		
	-	-	0-43690	40/92	20	6-40022-FU-L-1 6-40022-FU-R-1	U 35 x 8		
Profine KBE 88	88274	88172	0-43690	40/92	16	6-40022-AK-L-1 6-40022-AK-R-1	U 35 x 8		
	88276	88172	0-43690	40/92	20	6-40022-FU-L-1 6-40022-FU-R-1	U 35 x 8		
Profine KBE 70 CL	70212	70102	0-43690	45/92	16	6-40022-AE-L-1 6-40022-AE-R-1	U 30 x 8		
Profine Kömmerling									
Kömmerling 76 AD	76204	76102	0-43690	40/92	16	6-40022-AK-L-1 6-40022-AK-R-1	U 35 x 8		
	76206	76102	0-43690	40/92	20	6-40022-FU-L-1 6-40022-FU-R-1	U 35 x 8		
Kömmerling 76 MD	76272 (76279)	76102	0-43690	40/92	16	6-40022-AK-L-1 6-40022-AK-R-1	U 35 x 8		
	-	-	0-43690	40/92	20	6-40022-FU-L-1 6-40022-FU-R-1	U 35 x 8		
Kömmerling 88	88274	88172	0-43690	40/92	16	6-40022-AK-L-1 6-40022-AK-R-1	U 35 x 8		
	88276	88172	0-43690	40/92	20	6-40022-FU-L-1 6-40022-FU-R-1	U 35 x 8		
Kömmerling EuroFutur Classic	2416	2402	0-43690	45/92	16	6-40022-AN-L-1 6-40022-AN-R-1	U 30 x 8		
Kömmerling EuroFutur Elegance	0116	0102	0-43690	45/92	16	6-40022-AN-L-1 6-40022-AN-R-1	U 30 x 8		

GU-SECURY Automatic-DR – 1750 mm



One-piece strikers/L&D strikers/Strikers/Safe-T-catch strikers/Hinge-side locking devices for PVC profile systems



L&D striker	Striker adjustable	Safe-T-catch striker	Hinge-side locking device		SECUREconnect	
			For safe-T-catch	Frame Wedged keep	Leaf Drill-in cam Length = 54 mm	Faceplate/leaf
216.5	181	227	120	115	350	350
PU = 5	PU = 20	PU = 5	PU = 6	PU = 6	PU = 1	PU = 1
						
6-37558-5X-L-1 6-37558-5X-R-1	6-40007-AK-0-1	6-31632-5X-L-1 6-31632-5X-R-1	6-28961-5X-0-1	6-28985-06-0-1	9-45903-09-0-1	6-35513-5X-L-1 6-35513-5X-R-1
6-37558-6H-L-1 6-37558-6H-R-1	6-40007-FU-0-1	6-31632-6H-L-1 6-31632-6H-R-1	6-28961-6H-0-1	6-28985-07-0-1	9-45903-10-0-1	6-35513-6H-L-1 6-35513-6H-R-1
6-37558-5X-L-1 6-37558-5X-R-1	6-40007-AK-0-1	6-31632-5X-L-1 6-31632-5X-R-1	6-28961-5X-0-1	6-28985-06-0-1	9-45903-09-0-1	6-35513-5X-L-1 6-35513-5X-R-1
6-37558-6H-L-1 6-37558-6H-R-1	6-40007-FU-0-1	6-31632-6H-L-1 6-31632-6H-R-1	6-28961-6H-0-1	6-28985-07-0-1	9-45903-10-0-1	6-35513-6H-L-1 6-35513-6H-R-1
6-37558-5X-L-1 6-37558-5X-R-1	6-40007-AK-0-1	6-31632-5X-L-1 6-31632-5X-R-1	6-28961-5X-0-1	6-28985-06-0-1	9-45903-09-0-1	6-35513-5X-L-1 6-35513-5X-R-1
6-37558-6H-L-1 6-37558-6H-R-1	6-40007-FU-0-1	6-31632-6H-L-1 6-31632-6H-R-1	6-28961-6H-0-1	6-28985-07-0-1	9-45903-10-0-1	6-35513-6H-L-1 6-35513-6H-R-1
6-37675-34-L-1 6-37675-34-R-1	6-40007-AE-0-1	6-31632-34-L-1 6-31632-34-R-1	6-28961-34-0-1	6-28985-06-0-1	9-45903-09-0-1	6-35513-34-L-1 6-35513-34-R-1
6-37558-5X-L-1 6-37558-5X-R-1	6-40007-AK-0-1	6-31632-5X-L-1 6-31632-5X-R-1	6-28961-5X-0-1	6-28985-06-0-1	9-45903-09-0-1	6-35513-5X-L-1 6-35513-5X-R-1
6-37558-6H-L-1 6-37558-6H-R-1	6-40007-FU-0-1	6-31632-6H-L-1 6-31632-6H-R-1	6-28961-6H-0-1	6-28985-07-0-1	9-45903-10-0-1	6-35513-6H-L-1 6-35513-6H-R-1
6-37558-5X-L-1 6-37558-5X-R-1	6-40007-AK-0-1	6-31632-5X-L-1 6-31632-5X-R-1	6-28961-5X-0-1	6-28985-06-0-1	9-45903-09-0-1	6-35513-5X-L-1 6-35513-5X-R-1
6-37558-6H-L-1 6-37558-6H-R-1	6-40007-FU-0-1	6-31632-6H-L-1 6-31632-6H-R-1	6-28961-6H-0-1	6-28985-07-0-1	9-45903-10-0-1	6-35513-6H-L-1 6-35513-6H-R-1
6-37558-5X-L-1 6-37558-5X-R-1	6-40007-AK-0-1	6-31632-5X-L-1 6-31632-5X-R-1	6-28961-5X-0-1	6-28985-06-0-1	9-45903-09-0-1	6-35513-5X-L-1 6-35513-5X-R-1
6-37558-6H-L-1 6-37558-6H-R-1	6-40007-FU-0-1	6-31632-6H-L-1 6-31632-6H-R-1	6-28961-6H-0-1	6-28985-07-0-1	9-45903-10-0-1	6-35513-6H-L-1 6-35513-6H-R-1
6-37675-31-L-1 6-37675-31-R-1	6-40007-AN-0-1	6-31632-31-L-1 6-31632-31-R-1	6-28961-31-0-1	6-28985-06-0-1	9-45903-09-0-1	6-35513-31-L-1 6-35513-31-R-1
6-37675-31-L-1 6-37675-31-R-1	6-40007-AN-0-1	6-31632-31-L-1 6-31632-31-R-1	6-28961-31-0-1	6-28985-06-0-1	9-45903-09-0-1	6-35513-31-L-1 6-35513-31-R-1

GU-SECURITY Automatic-DR – 1750 mm

One-piece strikers/L&D strikers/Strikers/Safe-T-catch strikers/Hinge-side locking devices for PVC profile systems









PVC profile system	GU-SECURITY Automatic-DR multi-point lock					One-piece striker adjustable			
	Leaf profile	Frame profile	Installation drawing	Backset/Distance	Face-plate [mm]	With interchangeable latch piece			
Dimension L [mm]						1750			
Packing unit						PU = 5			
Profine Trocal									
Profine Trocal 76 AD	76204	76102	0-43690	40/92	16	6-40022-AK-L-1 6-40022-AK-R-1	U 35 x 8		
	76206	76102	0-43690	40/92	20	6-40022-FU-L-1 6-40022-FU-R-1	U 35 x 8		
Profine Trocal 76 MD	76272 (76279)	76102	0-43690	40/92	16	6-40022-AK-L-1 6-40022-AK-R-1	U 35 x 8		
	-	-	0-43690	40/92	20	6-40022-FU-L-1 6-40022-FU-R-1	U 35 x 8		
Profine Trocal 88	88274	88172	0-43690	40/92	16	6-40022-AK-L-1 6-40022-AK-R-1	U 35 x 8		
	88276	88172	0-43690	40/92	20	6-40022-FU-L-1 6-40022-FU-R-1	U 35 x 8		
Profine Trocal InnoNova_70.A5	622400	610200	0-43690	55/92	20	6-40022-BP-L-1 6-40022-BP-R-1	U 30 x 8		
Rehau									
Rehau Brillant-Design 70	550 160	550 680	0-43690	35/92	16	6-40022-AH-L-1 6-40022-AH-R-1	U 35 x 8		
Rehau Geneo®	1532965	1532835	0-43690	45/92	16	6-40022-AL-L-1 6-40022-AL-R-1	U 35 x 8		
Rehau Synego®	1537295	1537015	0-43690	35/92	16	6-40022-BK-L-1 6-40022-BK-R-1	U 35 x 8		
Rehau Character Design 80	1537295	1539005	0-43690	35/92	16	6-40022-BK-L-1 6-40022-BK-R-1	U 35 x 8		
Salamander / Brüggmann									
Salamander Streamline 3D	211 240	110 230	0-43690	45/92	20	6-40022-AR-L-1 6-40022-AR-R-1	U 35 x 8		
Salamander Streamline AD 76	251 040	250 230	0-43690	45/92	20	6-40022-AR-L-1 6-40022-AR-R-1	U 35 x 8		
Streamline MD	-	-	0-43690	45/92	20	6-40022-AR-L-1 6-40022-AR-R-1	U 35 x 8		
bluEvolution 92 (Schraubachse 22mm)	171 040	170 430	0-43690	55/92	16	6-40022-DL-L-1 6-40022-DL-R-1	U 35 x 8		
Brüggmann bluEvolution 82	HO8550	HP9220 (HO9020)	0-43690	55/92	20	6-40022-CP-L-1 6-40022-CP-R-1	U 35 x 8		
Schüco									
Schüco Corona CT 70 AS	9108	8597 (8864)	0-43690	45/92	16	6-40022-AB-L-1 6-40022-AB-R-1	U 30 x 8		
Schüco Corona CT 70 MD	76272	76172	0-43690	45/92	16	6-40022-AB-L-1 6-40022-AB-R-1	U 30 x 8		
Schüco Corona SI 82	8813 (9147)	9161	0-43690	45/92	16	6-40022-AB-L-1 6-40022-AB-R-1	U 30 x 8		
Schüco Living 82	9433	9412 (9422)	0-43690	45/92	16	6-40022-AB-L-1 6-40022-AB-R-1	U 30 x 8		

GU-SECURY Automatic-DR – 1750 mm



One-piece strikers/L&D strikers/Strikers/Safe-T-catch strikers/Hinge-side locking devices for PVC profile systems



L&D striker	Striker adjustable	Safe-T-catch striker	Hinge-side locking device		SECUREconnect	
			For safe-T-catch	Frame Wedged keep	Leaf Drill-in cam Length = 54 mm	Faceplate/leaf
216.5	181	227	120	115	350	350
PU = 5	PU = 20	PU = 5	PU = 6	PU = 6	PU = 1	PU = 1
						
6-37558-5X-L-1 6-37558-5X-R-1	6-40007-AK-0-1	6-31632-5X-L-1 6-31632-5X-R-1	6-28961-5X-0-1	6-28985-06-0-1	9-45903-09-0-1	6-35513-5X-L-1 6-35513-5X-R-1
6-37558-6H-L-1 6-37558-6H-R-1	6-40007-FU-0-1	6-31632-6H-L-1 6-31632-6H-R-1	6-28961-6H-0-1	6-28985-07-0-1	9-45903-10-0-1	6-35513-6H-L-1 6-35513-6H-R-1
6-37558-5X-L-1 6-37558-5X-R-1	6-40007-AK-0-1	6-31632-5X-L-1 6-31632-5X-R-1	6-28961-5X-0-1	6-28985-06-0-1	9-45903-09-0-1	6-35513-5X-L-1 6-35513-5X-R-1
6-37558-6H-L-1 6-37558-6H-R-1	6-40007-FU-0-1	6-31632-6H-L-1 6-31632-6H-R-1	6-28961-6H-0-1	6-28985-07-0-1	9-45903-10-0-1	6-35513-6H-L-1 6-35513-6H-R-1
6-37558-5X-L-1 6-37558-5X-R-1	6-40007-AK-0-1	6-31632-5X-L-1 6-31632-5X-R-1	6-28961-5X-0-1	6-28985-06-0-1	9-45903-09-0-1	6-35513-5X-L-1 6-35513-5X-R-1
6-37558-6H-L-1 6-37558-6H-R-1	6-40007-FU-0-1	6-31632-6H-L-1 6-31632-6H-R-1	6-28961-6H-0-1	6-28985-07-0-1	9-45903-10-0-1	6-35513-6H-L-1 6-35513-6H-R-1
6-37675-83-L-1 6-37675-83-R-1	6-40007-BP-0-1	6-31632-83-L-1 6-31632-83-R-1	6-28961-83-0-1	6-28985-07-0-1	9-45903-10-0-1	6-35513-83-L-1 6-35513-83-R-1
6-37558-62-L-1 6-37558-62-R-1	6-40007-AH-0-1	6-31632-62-L-1 6-31632-62-R-1	6-28961-62-0-1	6-28985-06-0-1	9-45903-09-0-1	6-35513-62-L-1 6-35513-62-R-1
6-37558-4W-L-1 6-37558-4W-R-1	6-40007-AL-0-1	6-31632-4W-L-1 6-31632-4W-R-1	6-28961-4W-0-1	6-28985-06-0-1	9-45903-09-0-1	6-35513-4W-L-1 6-35513-4W-R-1
6-37558-5A-L-1 6-37558-5A-R-1	6-40007-BK-0-1	6-31632-5A-L-1 6-31632-5A-R-1	6-28961-5A-0-1	6-28985-06-0-1	9-45903-09-0-1	6-35513-5Y-L-1 6-35513-5Y-R-1
6-37558-5A-L-1 6-37558-5A-R-1	6-40007-BK-0-1	6-31632-5A-L-1 6-31632-5A-R-1	6-28961-5A-0-1	6-28985-06-0-1	9-45903-09-0-1	6-35513-5Y-L-1 6-35513-5Y-R-1
6-37558-2R-L-1 6-37558-2R-R-1	6-40007-AR-0-1	6-31632-2R-L-1 6-31632-2R-R-1	6-28961-2R-0-1T	6-28985-07-0-1	9-45903-10-0-1	6-35513-2R-L-1 6-35513-2R-R-1
6-37558-2R-L-1 6-37558-2R-R-1	6-40007-AR-0-1	6-31632-2R-L-1 6-31632-2R-R-1	6-28961-2R-0-1T	6-28985-07-0-1	9-45903-10-0-1	6-35513-2R-L-1 6-35513-2R-R-1
6-37558-2R-L-1 6-37558-2R-R-1	6-40007-AR-0-1	6-31632-2R-L-1 6-31632-2R-R-1	6-28961-2R-0-1T	6-28985-07-0-1	9-45903-10-0-1	6-35513-2R-L-1 6-35513-2R-R-1
6-37558-5Y-L-1 6-37558-5Y-R-1	6-40007-DL-0-1	6-31632-5Y-L-1 6-31632-5Y-R-1	6-28961-5Y-0-1T ^[2]	6-28985-06-0-1	9-45903-09-0-1	6-35513-5Y-L-1 6-35513-5Y-R-1
6-37558-5J-L-1 6-37558-5J-R-1	6-40007-CP-0-1	6-31632-5J-L-1 6-31632-5J-R-1	6-28961-5J-0-1	6-28985-07-0-1	9-45903-10-0-1	6-35513-5J-L-1 6-35513-5J-R-1
6-37675-2T-L-1 6-37675-2T-R-1	6-40007-AB-0-1	6-31632-2T-L-1 6-31632-2T-R-1	6-28961-2T-0-1	6-28985-06-0-1	9-45903-09-0-1	6-35513-2T-L-1 6-35513-2T-R-1
6-37675-2T-L-1 6-37675-2T-R-1	6-40007-AB-0-1	6-31632-2T-L-1 6-31632-2T-R-1	6-28961-2T-0-1	6-28985-06-0-1	9-45903-09-0-1	6-35513-2T-L-1 6-35513-2T-R-1
6-37675-2T-L-1 6-37675-2T-R-1	6-40007-AB-0-1	6-31632-2T-L-1 6-31632-2T-R-1	6-28961-2T-0-1	6-28985-06-0-1	9-45903-09-0-1	6-35513-2T-L-1 6-35513-2T-R-1
6-37675-2T-L-1 6-37675-2T-R-1	6-40007-AB-0-1	6-31632-2T-L-1 6-31632-2T-R-1	6-28961-2T-0-1	6-28985-06-0-1	9-45903-09-0-1	6-35513-2T-L-1 6-35513-2T-R-1

^[2] on request

GU-SECURITY Automatic-DR – 1750 mm

One-piece strikers/L&D strikers/Strikers/Safe-T-catch strikers/Hinge-side locking devices for PVC profile systems









PVC profile system	GU-SECURITY Automatic-DR multi-point lock					One-piece striker adjustable		
	Leaf profile	Frame profile	Installation drawing	Backset/Distance	Face-plate [mm]	With interchangeable latch piece		
Dimension L [mm]						1750		
Packing unit						PU = 5		
Veka								
Veka Topline AD	103,202	101,205	0-43690	35/92	16	6-40022-AB-L-1 6-40022-AB-R-1	U 30 x 8	
	105,200	101,205	0-43690	45/92	U 24 x 6	6-40022-EH-L-1 6-40022-EH-R-1	U 30 x 5	
Veka Topline 70 MD	103,222	101,222	0-43690	45/92	16	6-40022-AB-L-1 6-40022-AB-R-1	U 30 x 8	
Veka Softline 70 AD (house entrance door)	105,232	101,214	0-43690	35/92	16	6-40022-AB-L-1 6-40022-AB-R-1	U 30 x 6	
Veka Softline 70 AD (secondary entrance door)	103,241	101,214	0-43690	45/92	U 24 x 6	6-40022-AM-L-1 6-40022-AM-R-1	U 30 x 5	
Veka Softline 70 MD (secondary entrance door)	103,279	101,277	0-43690	35/92	16	6-40022-AB-L-1 6-40022-AB-R-1	U 30 x 8	
Veka Softline 70 MD (secondary entrance door)	-	-	0-43690	45/92	U 24 x 6	6-40022-AM-L-1 6-40022-AM-R-1	U 30 x 5	
Veka Softline 82 AD	103,380	101,294	0-43690	50/92	U 24 x 6	6-40022-AM-L-1 6-40022-AM-R-1	U 30 x 5	
Veka Softline 76	105,400	101,351	0-43690	50/92	U 24 x 6	6-40022-AM-L-1 6-40022-AM-R-1	U 30 x 5	

GU-SECURY Automatic-DR – 1750 mm



One-piece strikers/L&D strikers/Strikers/Safe-T-catch strikers/Hinge-side locking devices for PVC profile systems



L&D striker	Striker adjustable	Safe-T-catch striker	Hinge-side locking device		SECUREconnect	
			For safe-T-catch	Frame Wedged keep	Leaf Drill-in cam Length = 54 mm	Faceplate/leaf
216.5	181	227	120	115	350	350
PU = 5	PU = 20	PU = 5	PU = 6	PU = 6	PU = 1	PU = 1
						
6-37675-2T-L-1 6-37675-2T-R-1	6-40007-AB-0-1	6-31632-2T-L-1 6-31632-2T-R-1	6-28961-2T-0-1	6-28985-06-0-1	9-45903-09-0-1	6-35513-2T-L-1 6-35513-2T-R-1
6-37930-01-L-1 6-37930-01-R-1	6-40007-EH-0-1	6-35978-01-L-1 6-35978-01-R-1	6-28961-88-0-1	6-28985-10-0-1	9-45903-13-0-1	6-37281-01-L-1 6-37281-01-R-1
6-37675-2T-L-1 6-37675-2T-R-1	6-40007-AB-0-1	6-31632-2T-L-1 6-31632-2T-R-1	6-28961-88-0-1	6-28985-06-0-1	9-45903-09-0-1	6-35513-2T-L-1 6-35513-2T-R-1
6-37675-2T-L-1 6-37675-2T-R-1	6-40007-AB-0-1	6-31632-2T-L-1 6-31632-2T-R-1	6-28961-2T-0-1	6-28985-06-0-1	9-45903-09-0-1	6-35513-2T-L-1 6-35513-2T-R-1
6-37930-01-L-1 6-37930-01-R-1	6-40007-AM-0-1	6-35978-01-L-1 6-35978-01-R-1	6-28961-88-0-1	6-28985-10-0-1	9-45903-13-0-1	6-37281-01-L-1 6-37281-01-R-1
6-37675-2T-L-1 6-37675-2T-R-1	6-40007-AB-0-1	6-31632-2T-L-1 6-31632-2T-R-1	6-28961-2T-0-1	6-28985-06-0-1	9-45903-09-0-1	6-35513-2T-L-1 6-35513-2T-R-1
6-37930-01-L-1 6-37930-01-R-1	6-40007-AM-0-1	6-35978-01-L-1 6-35978-01-R-1	6-28961-88-0-1	6-28985-10-0-1	9-45903-13-0-1	6-37281-01-L-1 6-37281-01-R-1
6-37930-01-L-1 6-37930-01-R-1	6-40007-AM-0-1	6-35978-01-L-1 6-35978-01-R-1	6-28961-88-0-1	6-28985-10-0-1	9-45903-13-0-1	6-37281-01-L-1 6-37281-01-R-1
6-37930-01-L-1 6-37930-01-R-1	6-40007-AM-0-1	6-35978-01-L-1 6-35978-01-R-1	6-28961-88-0-1	6-28985-10-0-1	9-45903-13-0-1	6-37281-01-L-1 6-37281-01-R-1

GU-SECURITY Automatic-DR – 1750 mm

One-piece strikers/L&D strikers/Strikers/Safe-T-catch strikers/Hinge-side locking devices for metal profile systems



Metal profile system	Mehrfachverriegelung GU-SECURITY Automatic-DR						One-piece striker 1-part With adjusting plate	
	Leaf profile	Frame profile	Installation drawing	Clearance [mm]	Backset/Distance	Face-plate [mm]		Face-plate [mm]
Dimension L [mm]							1750	
Packing unit							PU = 5	
Akotherm								
Akotherm AT 720	6477	6575	0-43777	14	35/92	U 24 x 6	6-40520-AA-0-1 6-40520-AA-0-8	24
Akotherm AT 730	2577	2575	0-43777	14	35/92	U 24 x 6	6-40520-AA-0-1 6-40520-AA-0-8	24
Akotherm AT 730 HI-S	2531	2502	0-43777	14	35/92	U 24 x 6	6-40520-AA-0-1 6-40520-AA-0-8	24
Akotherm AT 740 SI	1551	1502	0-43777	14	35/92	U 24 x 6	6-40520-AA-0-1 6-40520-AA-0-8	24
Alumil								
Alumil M11000	-	-	0-43777	11.5	33/92	24	6-40520-AC-0-1 6-40520-AC-0-8	U 24 x 6
Alumil M11000-2	-	-	0-43777	14.5	33/92	U 24 x 6	6-40520-AC-0-1 6-40520-AC-0-8	U 24 x 6
Alumil M11500	-	-	0-43777	11.5	33/92	24	6-40520-AC-0-1 6-40520-AC-0-8	U 24 x 6
Alumil M11500-2	-	-	0-43777	14.5	45/92	U 24 x 6	6-40520-AC-0-1 6-40520-AC-0-8	U 24 x 6
Alumil M940	-	-	0-43777	11.5	33/92	24	6-40520-AC-0-1 6-40520-AC-0-8	U 24 x 6
Alumil M9400	-	-	0-43777	11.5	33/92	24	6-40520-AC-0-1 6-40520-AC-0-8	U 24 x 6









GU-SECURY Automatic-DR – 1750 mm



One-piece strikers/L&D strikers/Strikers/Safe-T-catch strikers/Hinge-side locking devices for metal profile systems



L&D striker	Striker adjustable	Safe-T-catch striker	Hinge-side locking device		SECUREconnect	
			For safe-T-catch	Frame Wedged keep	Leaf Drill-in cam Length = 54 mm	Faceplate/leaf
216.5	181	227	120	115	350	350
PU = 5	PU = 20	PU = 5	PU = 6	PU = 6	PU = 1	PU = 1
						
6-37368-01-L-1 6-37368-01-R-1 6-37368-01-L-8 6-37368-01-R-8	6-40007-AA-0-1 6-40007-AA-0-8	6-29505-00-L-1 6-29505-00-R-1 6-29505-00-L-8 6-29505-00-R-8	6-29525-00-0-1 6-29525-00-0-8	6-28985-08-0-1 6-28985-08-0-8	9-45903-13-0-1 9-45903-13-0-8	9-45903-11-0-1 9-45903-11-0-8
6-37368-01-L-1 6-37368-01-R-1 6-37368-01-L-8 6-37368-01-R-8	6-40007-AA-0-1 6-40007-AA-0-8	6-29505-00-L-1 6-29505-00-R-1 6-29505-00-L-8 6-29505-00-R-8	6-29525-00-0-1 6-29525-00-0-8	6-28985-08-0-1 6-28985-08-0-8	9-45903-13-0-1 9-45903-13-0-8	9-45903-11-0-1 9-45903-11-0-8
6-37368-01-L-1 6-37368-01-R-1 6-37368-01-L-8 6-37368-01-R-8	6-40007-AA-0-1 6-40007-AA-0-8	6-29505-00-L-1 6-29505-00-R-1 6-29505-00-L-8 6-29505-00-R-8	6-29525-00-0-1 6-29525-00-0-8	6-28985-08-0-1 6-28985-08-0-8	9-45903-13-0-1 9-45903-13-0-8	9-45903-11-0-1 9-45903-11-0-8
6-37368-01-L-1 6-37368-01-R-1 6-37368-01-L-8 6-37368-01-R-8	6-40007-AA-0-1 6-40007-AA-0-8	6-29505-00-L-1 6-29505-00-R-1 6-29505-00-L-8 6-29505-00-R-8	6-29525-00-0-1 6-29525-00-0-8	6-28985-08-0-1 6-28985-08-0-8	9-45903-13-0-1 9-45903-13-0-8	9-45903-11-0-1 9-45903-11-0-8
6-37367-01-L-1 6-37367-01-R-1 6-37367-01-L-8 6-37367-01-R-8	6-40007-AC-0-1 6-40007-AC-0-8	6-29511-00-L-1 6-29511-00-R-1 6-29511-00-L-8 6-29511-00-R-8	6-29526-00-0-1 6-29526-00-0-8	6-28985-10-0-1 6-28985-10-0-8	9-45903-11-0-1 9-45903-11-0-8	6-35515-04-0-1 6-35515-04-0-8
6-37367-01-L-1 6-37367-01-R-1 6-37367-01-L-8 6-37367-01-R-8	6-40007-AC-0-1 6-40007-AC-0-8	6-29511-00-L-1 6-29511-00-R-1 6-29511-00-L-8 6-29511-00-R-8	6-29526-00-0-1 6-29526-00-0-8	6-28985-08-0-1 6-28985-08-0-8	9-45903-13-0-1 9-45903-13-0-8	6-35515-04-0-1 6-35515-04-0-8
6-37367-01-L-1 6-37367-01-R-1 6-37367-01-L-8 6-37367-01-R-8	6-40007-AC-0-1 6-40007-AC-0-8	6-29511-00-L-1 6-29511-00-R-1 6-29511-00-L-8 6-29511-00-R-8	6-29526-00-0-1 6-29526-00-0-8	6-28985-10-0-1 6-28985-10-0-8	9-45903-11-0-1 9-45903-11-0-8	6-35515-04-0-1 6-35515-04-0-8
6-37367-01-L-1 6-37367-01-R-1 6-37367-01-L-8 6-37367-01-R-8	6-40007-AC-0-1 6-40007-AC-0-8	6-29511-00-L-1 6-29511-00-R-1 6-29511-00-L-8 6-29511-00-R-8	6-29526-00-0-1 6-29526-00-0-8	6-28985-08-0-1 6-28985-08-0-8	9-45903-13-0-1 9-45903-13-0-8	6-35515-04-0-1 6-35515-04-0-8
6-37367-01-L-1 6-37367-01-R-1 6-37367-01-L-8 6-37367-01-R-8	6-40007-AC-0-1 6-40007-AC-0-8	6-29511-00-L-1 6-29511-00-R-1 6-29511-00-L-8 6-29511-00-R-8	6-29526-00-0-1 6-29526-00-0-8	6-28985-10-0-1 6-28985-10-0-8	9-45903-11-0-1 9-45903-11-0-8	6-35515-04-0-1 6-35515-04-0-8
6-37367-01-L-1 6-37367-01-R-1 6-37367-01-L-8 6-37367-01-R-8	6-40007-AC-0-1 6-40007-AC-0-8	6-29511-00-L-1 6-29511-00-R-1 6-29511-00-L-8 6-29511-00-R-8	6-29526-00-0-1 6-29526-00-0-8	6-28985-10-0-1 6-28985-10-0-8	9-45903-11-0-1 9-45903-11-0-8	6-35515-04-0-1 6-35515-04-0-8

GU-SECURITY Automatic-DR – 1750 mm

One-piece strikers/L&D strikers/Strikers/Safe-T-catch strikers/Hinge-side locking devices for metal profile systems



Metal profile system	GU-SECURITY Automatic-DR multi-point lock						One-piece striker 1-part With adjusting plate	
	Leaf profile	Frame profile	Installation drawing	Clearance [mm]	Backset/Distance	Face-plate [mm]		Face-plate [mm]
Dimension L [mm]							1750	
Packing unit							PU = 5	
Feal								
Feal T65 VS	–	–	0-43777	16	35/92	U 24 x 6	6-40520-AC-0-1 6-40520-AC-0-8	U 24 x 6
Feal T85 VS	–	–	0-43777	16	35/92	U 24 x 6	6-40520-AC-0-1 6-40520-AC-0-8	U 24 x 6
Gutmann								
Gutmann S70	270280	270180	0-43777	17	35/92	U 24 x 6	6-40520-AC-0-1 6-40520-AC-0-8	U 24 x 6
Heroal								
Heroal 065	9381	9380	0-43777	16.6	33/92	U 24 x 6	6-40520-AC-0-1 6-40520-AC-0-8	U 24 x 6
Heroal 090	9081	9080	0-43777	16.6	33/92	U 24 x 6	6-40520-AC-0-1 6-40520-AC-0-8	U 24 x 6
Heroal 110	15481	15480	0-43777	16.6	33/92	U 24 x 6	6-40520-AC-0-1 6-40520-AC-0-8	U 24 x 6
Heroal D 72	21191	21180	0-43777	16.6	45/92	U 24 x 6	6-40520-AC-0-1 6-40520-AC-0-8	U 24 x 6
Heroal D 92 UD	23081	23060	0-43777	14	50/92	U 24 x 6	6-40520-AA-0-1 6-40520-AA-0-8	24









GU-SECURY Automatic-DR – 1750 mm



One-piece strikers/L&D strikers/Strikers/Safe-T-catch strikers/Hinge-side locking devices for metal profile systems



L&D striker	Striker adjustable	Safe-T-catch striker	Hinge-side locking device		SECUREconnect	
			For safe-T-catch	Frame Wedged keep	Leaf Drill-in cam Length = 54 mm	Faceplate/leaf
216.5	181	227	120	115	350	350
PU = 5	PU = 20	PU = 5	PU = 6	PU = 6	PU = 1	PU = 1
						
6-37367-01-L-1 6-37367-01-R-1 6-37367-01-L-8 6-37367-01-R-8	6-40007-AC-0-1 6-40007-AC-0-8	6-29511-00-L-1 6-29511-00-R-1 6-29511-00-L-8 6-29511-00-R-8	6-29526-00-0-1 6-29526-00-0-8	6-28985-08-0-1 6-28985-08-0-8	9-45903-13-0-1 9-45903-13-0-8	9-45903-11-0-1 9-45903-11-0-8
6-37367-01-L-1 6-37367-01-R-1 6-37367-01-L-8 6-37367-01-R-8	6-40007-AC-0-1 6-40007-AC-0-8	6-29511-00-L-1 6-29511-00-R-1 6-29511-00-L-8 6-29511-00-R-8	6-29526-00-0-1 6-29526-00-0-8	6-28985-08-0-1 6-28985-08-0-8	9-45903-13-0-1 9-45903-13-0-8	6-35515-04-0-1 6-35515-04-0-8
6-37367-03-L-1 6-37367-03-R-1 6-37367-03-L-8 6-37367-03-R-8	6-40007-AC-0-1 6-40007-AC-0-8	6-29511-00-L-1 6-29511-00-R-1 6-29511-00-L-8 6-29511-00-R-8	6-29526-00-0-1 6-29526-00-0-8	6-28985-08-0-1 6-28985-08-0-8	9-45903-13-0-1 9-45903-13-0-8	6-35515-04-0-1 6-35515-04-0-8
6-37367-01-L-1 6-37367-01-R-1 6-37367-01-L-8 6-37367-01-R-8	6-40007-AC-0-1 6-40007-AC-0-8	6-29511-00-L-1 6-29511-00-R-1 6-29511-00-L-8 6-29511-00-R-8	6-29526-00-0-1 6-29526-00-0-8	6-28985-08-0-1 6-28985-08-0-8	9-45903-13-0-1 9-45903-13-0-8	6-35515-04-0-1 6-35515-04-0-8
6-37367-01-L-1 6-37367-01-R-1 6-37367-01-L-8 6-37367-01-R-8	6-40007-AC-0-1 6-40007-AC-0-8	6-29511-00-L-1 6-29511-00-R-1 6-29511-00-L-8 6-29511-00-R-8	6-29526-00-0-1 6-29526-00-0-8	6-28985-08-0-1 6-28985-08-0-8	9-45903-13-0-1 9-45903-13-0-8	6-35515-04-0-1 6-35515-04-0-8
6-37367-01-L-1 6-37367-01-R-1 6-37367-01-L-8 6-37367-01-R-8	6-40007-AC-0-1 6-40007-AC-0-8	6-29511-00-L-1 6-29511-00-R-1 6-29511-00-L-8 6-29511-00-R-8	6-29526-00-0-1 6-29526-00-0-8	6-28985-08-0-1 6-28985-08-0-8	9-45903-13-0-1 9-45903-13-0-8	6-35515-04-0-1 6-35515-04-0-8
6-37368-01-L-1 6-37368-01-R-1 6-37368-01-L-8 6-37368-01-R-8	6-40007-AA-0-1 6-40007-AA-0-8	6-29505-00-L-1 6-29505-00-R-1 6-29505-00-L-8 6-29505-00-R-8	6-29525-00-0-1 6-29525-00-0-8	6-28985-08-0-1 6-28985-08-0-8	9-45903-13-0-1 9-45903-13-0-8	6-35515-04-0-1 6-35515-04-0-8

GU-SECURITY Automatic-DR – 1750 mm

One-piece strikers/L&D strikers/Strikers/Safe-T-catch strikers/Hinge-side locking devices for metal profile systems



Metal profile system	GU-SECURITY Automatic-DR multi-point lock						One-piece striker 1-part With adjusting plate	
	Leaf profile	Frame profile	Installation drawing	Clearance [mm]	Backset/Distance	Face-plate [mm]		Face-plate [mm]
Dimension L [mm]							1750	
Packing unit							PU = 5	
Hueck								
Hueck Lambda 57S	B811200	B811010	0-43777	13	35/92	U 24 x 6	6-40520-AA-0-1 6-40520-AA-0-8	24
Hueck Lambda 65M	B808200	B808010	0-43777	13	35/92	U 24 x 6	6-40520-AA-0-1 6-40520-AA-0-8	24
Hueck Lambda 75DS	-	-	0-43777	13	35/92	U 24 x 6	6-40520-AC-0-1 6-40520-AC-0-8	U 24 x 6
Hueck Lambda 77L	B805220	B805010	0-43777	13	40/92	24	6-40520-AC-0-1 6-40520-AC-0-8	U 24 x 6
Hueck Lambda Duo 90	-	-	0-43777	16	40/92	U 24 x 6	6-40520-AC-0-1 6-40520-AC-0-8	U 24 x 6
Kawneer								
Kawneer AA 720	3000499	3000501	0-43777	14	35/92	U 24 x 6	6-40520-AA-0-1 6-40520-AA-0-8	24
Raico								
Raico Frame+ 75D	314100	314000	0-43777	17	45/92	U 24 x 6	6-40520-AC-0-1 6-40520-AC-0-8	U 24 x 6
Reynaers								
Reynaers CS 77	008026	0081898	0-43777	16	35/92	U 24 x 6	6-40022-AC-0-1 6-40022-AC-0-8	U 24 x 6
Reynaers CS 86 HI	1081026	1080898	0-43777	16	35/92	U 24 x 6	6-40022-AC-0-1 6-40022-AC-0-8	U 24 x 6









GU-SECURY Automatic-DR – 1750 mm



One-piece strikers/L&D strikers/Strikers/Safe-T-catch strikers/Hinge-side locking devices for metal profile systems



L&D striker	Striker adjustable	Safe-T-catch striker	Hinge-side locking device		SECUREconnect	
			For safe-T-catch	Frame Wedged keep	Leaf Drill-in cam Length = 54 mm	Faceplate/leaf
216.5	181	227	120	115	350	350
PU = 5	PU = 20	PU = 5	PU = 6	PU = 6	PU = 1	PU = 1
						
6-37368-01-L-1 6-37368-01-R-1 6-37368-01-L-8 6-37368-01-R-8	6-40007-AA-0-1 6-40007-AA-0-8	6-29505-00-L-1 6-29505-00-R-1 6-29505-00-L-8 6-29505-00-R-8	6-29525-00-0-1 6-29525-00-0-8	6-28985-08-0-1 6-28985-08-0-8	9-45903-13-0-1 9-45903-13-0-8	9-45903-11-0-1 9-45903-11-0-8
6-37368-01-L-1 6-37368-01-R-1 6-37368-01-L-8 6-37368-01-R-8	6-40007-AA-0-1 6-40007-AA-0-8	6-29505-00-L-1 6-29505-00-R-1 6-29505-00-L-8 6-29505-00-R-8	6-29525-00-0-1 6-29525-00-0-8	6-28985-08-0-1 6-28985-08-0-8	9-45903-13-0-1 9-45903-13-0-8	9-45903-11-0-1 9-45903-11-0-8
6-37367-01-L-1 6-37367-01-R-1 6-37367-01-L-8 6-37367-01-R-8	6-40007-AC-0-1 6-40007-AC-0-8	6-29511-00-L-1 6-29511-00-R-1 6-29511-00-L-8 6-29511-00-R-8	6-29526-00-0-1 6-29526-00-0-8	6-28985-08-0-1 6-28985-08-0-8	9-45903-13-0-1 9-45903-13-0-8	6-35515-04-0-1 6-35515-04-0-8
6-37367-03-L-1 6-37367-03-R-1 6-37367-03-L-8 6-37367-03-R-8	6-40007-AC-0-1 6-40007-AC-0-8	6-29511-00-L-1 6-29511-00-R-1 6-29511-00-L-8 6-29511-00-R-8	6-29526-00-0-1 6-29526-00-0-8	6-28985-10-0-1 6-28985-10-0-8	9-45903-11-0-1 9-45903-11-0-8	6-35515-04-0-1 6-35515-04-0-8
6-37367-01-L-1 6-37367-01-R-1 6-37367-01-L-8 6-37367-01-R-8	6-40007-AC-0-1 6-40007-AC-0-8	6-29511-00-L-1 6-29511-00-R-1 6-29511-00-L-8 6-29511-00-R-8	6-29526-00-0-1 6-29526-00-0-8	6-28985-08-0-1 6-28985-08-0-8	9-45903-13-0-1 9-45903-13-0-8	6-35515-04-0-1 6-35515-04-0-8
6-37368-01-L-1 6-37368-01-R-1 6-37368-01-L-8 6-37368-01-R-8	6-40007-AA-0-1 6-40007-AA-0-8	6-29505-00-L-1 6-29505-00-R-1 6-29505-00-L-8 6-29505-00-R-8	6-29525-00-0-1 6-29525-00-0-8	6-28985-08-0-1 6-28985-08-0-8	9-45903-13-0-1 9-45903-13-0-8	9-45903-11-0-1 9-45903-11-0-8
6-37367-01-L-1 6-37367-01-R-1 6-37367-01-L-8 6-37367-01-R-8	6-40007-AC-0-1 6-40007-AC-0-8	6-29511-00-L-1 6-29511-00-R-1 6-29511-00-L-8 6-29511-00-R-8	6-29526-00-0-1 6-29526-00-0-8	6-28985-08-0-1 6-28985-08-0-8	9-45903-13-0-1 9-45903-13-0-8	6-35515-04-0-1 6-35515-04-0-8
6-37367-03-L-1 6-37367-03-R-1 6-37367-03-L-8 6-37367-03-R-8	6-40007-AC-0-1 6-40007-AC-0-8	6-29511-00-L-1 6-29511-00-R-1 6-29511-00-L-8 6-29511-00-R-8	6-29526-00-0-1 6-29526-00-0-8	6-28985-08-0-1 6-28985-08-0-8	9-45903-13-0-1 9-45903-13-0-8	6-35515-04-0-1 6-35515-04-0-8
6-37367-03-L-1 6-37367-03-R-1 6-37367-03-L-8 6-37367-03-R-8	6-40007-AC-0-1 6-40007-AC-0-8	6-29511-00-L-1 6-29511-00-R-1 6-29511-00-L-8 6-29511-00-R-8	6-29526-00-0-1 6-29526-00-0-8	6-28985-08-0-1 6-28985-08-0-8	9-45903-13-0-1 9-45903-13-0-8	6-35515-04-0-1 6-35515-04-0-8

GU-SECURITY Automatic-DR – 1750 mm

One-piece strikers/L&D strikers/Strikers/Safe-T-catch strikers/Hinge-side locking devices for metal profile systems



Metal profile system	GU-SECURITY Automatic-DR multi-point lock						One-piece striker 1-part With adjusting plate	
	Leaf profile	Frame profile	Installation drawing	Clearance [mm]	Backset/Distance	Face-plate [mm]		Face-plate [mm]
Dimension L [mm]							1750	
Packing unit							PU = 5	
SAPA								
SAPA Aventis 75	E8V052	32K82	0-43777	12	35/92	24	6-40520-AC-0-1 6-40520-AC-0-8	U 24 x 6
SAPA Ekonal E 65	38V12	38K82	0-43777	12	35/92	U 24 x 6	6-40520-AA-0-1 6-40520-AA-0-8	24
SAPA Ekonal E 75 plus	34V12	34K82	0-43777	12	35/92	U 24 x 6	6-40520-AA-0-1 6-40520-AA-0-8	24
Schüco								
Schüco ADS 75 Simply Smart	–	–	0-43777	16	33/92	U 24 x 6	6-40520-AC-0-1 6-40520-AC-0-8	U 24 x 6
Schüco ADS 70 HD	–	–	0-43777	16	35/92	U 24 x 6	6-40520-AC-0-1 6-40520-AC-0-8	U 24 x 6
Schüco Royal S 65	167 050	167 030	0-43777	15.5	35/92	U 24 x 6	6-40520-AC-0-1 6-40520-AC-0-8	U 24 x 6
Schüco Royal S 70	171 050	171 030	0-43777	15.5	35/92	U 24 x 6	6-40520-AC-0-1 6-40520-AC-0-8	U 24 x 6
TKI								
TKI 755	75502066	75501061	0-43777	16	35/92	U 24 x 6	6-40520-AC-0-1 6-40520-AC-0-8	U 24 x 6
Wicona								
Wicona Wicstyle 65	1021003	1021001	0-43777	12	35/92	24	6-40520-AC-0-1 6-40520-AC-0-8	U 24 x 6
Wicona Wicstyle 77	1021204	1021201	0-43777	12	35/92	24	6-40520-AC-0-1 6-40520-AC-0-8	U 24 x 6
Wicona Wicstyle 88	1021401	1021400	0-43777	11	35/92	24	6-40520-AA-0-1 6-40520-AA-0-8	24









GU-SECURY Automatic-DR – 1750 mm



One-piece strikers/L&D strikers/Strikers/Safe-T-catch strikers/Hinge-side locking devices for metal profile systems



L&D striker	Striker adjustable	Safe-T-catch striker	Hinge-side locking device		SECUREconnect	
			For safe-T-catch	Frame Wedged keep	Leaf Drill-in cam Length = 54 mm	Faceplate/leaf
216.5	181	227	120	115	350	350
PU = 5	PU = 20	PU = 5	PU = 6	PU = 6	PU = 1	PU = 1
						
6-37367-03-L-1 6-37367-03-R-1	6-40007-AC-0-1 6-40007-AC-0-8	6-29511-00-L-1 6-29511-00-R-1 6-29511-00-L-8 6-29511-00-R-8	6-29526-00-0-1 6-29526-00-0-8	6-28985-10-0-1 6-28985-10-0-8	9-45903-11-0-1 9-45903-11-0-8	6-35515-04-0-1 6-35515-04-0-8
6-37368-01-L-1 6-37368-01-R-1 6-37368-01-L-8 6-37368-01-R-8	6-40007-AA-0-1 6-40007-AA-0-8	6-29505-00-L-1 6-29505-00-R-1 6-29505-00-L-8 6-29505-00-R-8	6-29525-00-0-1 6-29525-00-0-8	6-28985-08-0-1 6-28985-08-0-8	9-45903-13-0-1 9-45903-13-0-8	9-45903-11-0-1 9-45903-11-0-8
6-37368-01-L-1 6-37368-01-R-1 6-37368-01-L-8 6-37368-01-R-8	6-40007-AA-0-1 6-40007-AA-0-8	6-29505-00-L-1 6-29505-00-R-1 6-29505-00-L-8 6-29505-00-R-8	6-29525-00-0-1 6-29525-00-0-8	6-28985-08-0-1 6-28985-08-0-8	9-45903-13-0-1 9-45903-13-0-8	9-45903-11-0-1 9-45903-11-0-8
6-37367-01-L-1 6-37367-01-R-1 6-37367-01-L-8 6-37367-01-R-8	6-40007-AC-0-1 6-40007-AC-0-8	6-29511-00-L-1 6-29511-00-R-1 6-29511-00-L-8 6-29511-00-R-8	6-29526-00-0-1 6-29526-00-0-8	6-28985-08-0-1 6-28985-08-0-8	9-45903-13-0-1 9-45903-13-0-8	6-35515-04-0-1 6-35515-04-0-8
6-37367-01-L-1 6-37367-01-R-1 6-37367-01-L-8 6-37367-01-R-8	6-40007-AC-0-1 6-40007-AC-0-8	6-29511-00-L-1 6-29511-00-R-1 6-29511-00-L-8 6-29511-00-R-8	6-29526-00-0-1 6-29526-00-0-8	6-28985-08-0-1 6-28985-08-0-8	9-45903-13-0-1 9-45903-13-0-8	6-35515-04-0-1 6-35515-04-0-8
6-37367-01-L-1 6-37367-01-R-1 6-37367-01-L-8 6-37367-01-R-8	6-40007-AC-0-1 6-40007-AC-0-8	6-29511-00-L-1 6-29511-00-R-1 6-29511-00-L-8 6-29511-00-R-8	6-29526-00-0-1 6-29526-00-0-8	6-28985-08-0-1 6-28985-08-0-8	9-45903-13-0-1 9-45903-13-0-8	6-35515-04-0-1 6-35515-04-0-8
6-37367-03-L-1 6-37367-03-R-1	6-40007-AC-0-1 6-40007-AC-0-8	6-29511-00-L-1 6-29511-00-R-1 6-29511-00-L-8 6-29511-00-R-8	6-29526-00-0-1 6-29526-00-0-8	6-28985-08-0-1 6-28985-08-0-8	9-45903-13-0-1 9-45903-13-0-8	6-35515-04-0-1 6-35515-04-0-8
6-37367-01-L-1 6-37367-01-R-1 6-37367-01-L-8 6-37367-01-R-8	6-40007-AC-0-1 6-40007-AC-0-8	6-29511-00-L-1 6-29511-00-R-1 6-29511-00-L-8 6-29511-00-R-8	6-29526-00-0-1 6-29526-00-0-8	6-28985-10-0-1 6-28985-10-0-8	9-45903-11-0-1 9-45903-11-0-8	6-35515-04-0-1 6-35515-04-0-8
6-37367-01-L-1 6-37367-01-R-1 6-37367-01-L-8 6-37367-01-R-8	6-40007-AC-0-1 6-40007-AC-0-8	6-29511-00-L-1 6-29511-00-R-1 6-29511-00-L-8 6-29511-00-R-8	6-29526-00-0-1 6-29526-00-0-8	6-28985-10-0-1 6-28985-10-0-8	9-45903-11-0-1 9-45903-11-0-8	6-35515-04-0-1 6-35515-04-0-8
6-37368-01-L-1 6-37368-01-R-1 6-37368-01-L-8 6-37368-01-R-8	6-40007-AA-0-1 6-40007-AA-0-8	6-29505-00-L-1 6-29505-00-R-1 6-29505-00-L-8 6-29505-00-R-8	6-29525-00-0-1 6-29525-00-0-8	6-28985-08-0-1 6-28985-08-0-8	9-45903-11-0-1 9-45903-11-0-8	9-45903-11-0-1 9-45903-11-0-8

GU-SECURY Automatic-DR – 1750 mm

One-piece strikers/L&D strikers/Strikers/Hinge-side locking devices/Safe-T-catch strikers for profile systems made of timber



Timber profile systems	GU-SECURY Automatic-DR multi-point lock			Adjustable one-piece striker		
	Faceplate [mm]	Axis [mm]	Clearance [mm]	1-piece, with interchangeable latch piece for installation of electric strike	1-piece, with interchangeable latch piece for installation of electric strike	Faceplate [mm]
Dimension L x W x D [mm]				1750	2310	
Packing unit				PU = 5	PU = 5	
Clearance						
Rebate clearance 4 mm, 28 x 9 mm	20	13	4	6-40022-AF-L-1 ^[1] 6-40022-AF-R-1 ^[1]	–	L 28 x 9
Leitz system						
Leitz system	20	15	4	6-40022-BF-L-1 ^[1] 6-40022-BF-R-1 ^[1]	6-40086-BF-L-1 6-40086-BF-R-1	U 30 x 10
Leitz system	20	13	4	6-40022-BC-L-1 ^[1] 6-40022-BC-R-1 ^[1]	6-40086-BC-L-1 6-40086-BC-R-1	U 30 x 10

^[1] Round faceplate ends









GU-SECURY Automatic-DR – 1750 mm



One-piece strikers/L&D strikers/Strikers/Hinge-side locking devices/Safe-T-catch strikers for profile systems made of timber



L&D striker L shape With inter- changeable latch piece	Striker To be milled in	Safe-T-catch striker	Hinge-side locking device 3 drill-in cams 3 wedged keeps	Cover strip for hinge-side locking device 3 cover strips	SECUREconnect	
					Faceplate/leaf	Faceplate/frame
250 x 28 x 9	on request	227	on request	900	350	350
PU = 5	PU = 20	PU = 5	PU = 2	PU = 2	PU = 1	PU = 1
						
6-29476-02-L-1 6-29476-02-R-1	6-40007-AF-0-1	6-29697-02-L-1 6-29697-02-R-1	K-14748-00-0-1	-	9-45903-03-0-1	9-45903-03-0-1
-	-	-	K-17093-00-0-1	K-17092-00-0-1	9-45903-03-0-1	9-45903-03-0-1
-	-	-	K-17093-00-0-1	K-17092-00-0-1	9-45903-03-0-1	9-45903-03-0-1

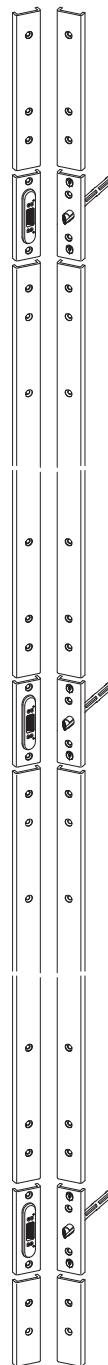

GU-SECURITY Automatic-DR – 1750 mm

Extensions (for one-piece striker) for timber, PVC and metal doors

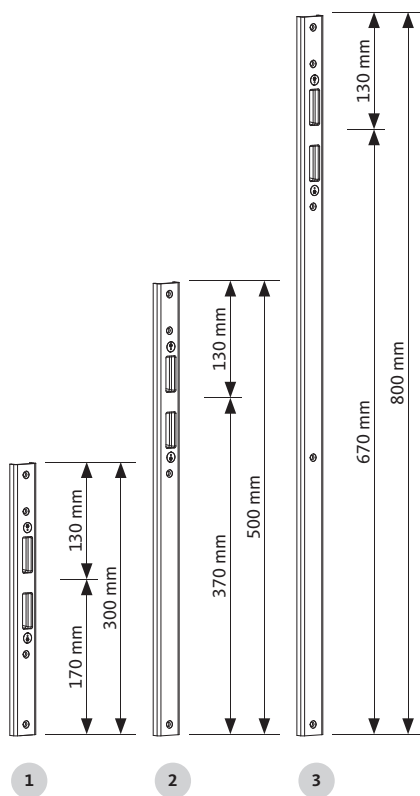

Extensions (for one-piece striker) for timber, PVC and metal doors

Designation	Faceplate [mm]	Faceplate end	PU	Order number
1 1-piece striker DR extension for locking position +300 mm	various	square or round	-	on request
2 1-piece striker DR extension for locking position +500 mm	various	square or round	-	on request
3 1-piece striker DR extension For locking position +800 mm	various	square or round	-	on request

Colour: 1 = ferGUard*silver, 8 = satin stainless steel

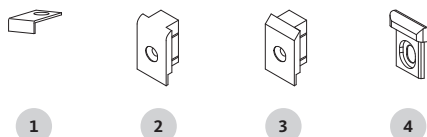

Clamping part/end piece for timber, PVC and metal doors

Designation	Faceplate [mm]	Shape	PU	Order number
1 Clamping part for flat faceplate	-	-	100	9-29498-00-0-1
2 End piece for flat faceplate	16	round	100	9-35946-01-0-1
	20	round	100	9-35946-02-0-1
3 End piece for flat faceplate	20	bevelled	100	9-35946-03-0-1
	24	bevelled	100	9-35946-04-0-1
4 End piece for U-faceplate	U 24 x 6	-	200	9-39909-01-0-6

Colour: 1 = ferGUard*silver, 6 = black coloured, RAL 9005

GU-SECURY Automatic-DR – 1750 mm

Extension piece (for one-piece striker) for timber, PVC and metal doors

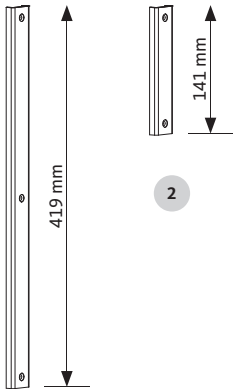

1

2

Extension piece (for one-piece striker) for timber, PVC and metal doors

Designation	Faceplate [mm]	Faceplate end	PU	Order number
1 Top extension piece L = 419 mm for SECURY one-piece strickers	U 30 x 10	square	10	9-48689-23-0-1 9-48689-23-0-8
	U 24 x 6	square	10	9-48689-29-0-1 9-48689-29-0-8
	U 24 x 6	square with end piece	10	6-39069-29-0-1 6-39069-29-0-8
	various	-	-	on request
2 Bottom extension piece L = 141 mm for SECURY one-piece strickers	U 30 x 10	square	10	9-48688-23-0-1 9-48688-23-0-8
	U 24 x 6	square	10	9-48688-29-0-1
	U 24 x 6	square with end piece	10	6-37850-29-0-1
	various	-	-	on request

Colour: 1 = ferGUard*silver, 8 = satin stainless steel



Indicative character of technical information, exclusion of liability

The technical documents are general information based on our experience and tests and therefore do not take any specific application into account. They are intended as general information and for initial orientation only, and must not be used as the decision-making basis. They reflect the version of the catalogue at the time of going to press. Although we have made every attempt to ensure the information provided here is accurate, it is non-binding. It should be adapted to the respective construction projects, usage and specific on-site demands. Due to further developments, and also to take current developments into account and exclude printing errors or other oversights or omissions, you can find the respective latest version of the binding technical documents at www.g-u.com. Be sure to use the latest edition of our technical documents.

The product images shown in the publication may differ from the actual product, particularly as a result of technical improvements. We would also like to draw your attention to the current information at the website mentioned above.

Image credits

Shutterstock:

Title, page 3 (entrance situation)

Title, page 3, page 7, page 9, page 11 (pictures of persons)

Getty Images:

Page 5, page 8

Publisher

Gretsch-Unitas GmbH

Baubeschläge

Johann-Maus-Str. 3

71254 Ditzingen, Germany

Tel. +49 (0) 71 56 3 01-0

Fax +49 71 56 3 01-293

www.g-u.com

Copyright notice

© All illustrations and texts in this publication are protected by copyright. Unless otherwise stated in the image credits, the rights belong to the Gretsch-Unitas group. Any use of copyright protected materials without the consent of the holder of the rights is prohibited.





WINDOW TECHNOLOGY
DOOR TECHNOLOGY
AUTOMATIC ENTRANCE SYSTEMS
BUILDING MANAGEMENT SYSTEMS

Gretsch-Unitas GmbH
Baubeschlage
Johann-Maus-Str. 3
D-71254 Ditzingen
Tel. +49 7156 301-0
Fax +49 7156 301-77980

BKS GmbH
Heidestr. 71
D-42549 Velbert
Tel. +49 2051 201-0
Fax +49 2051 201-9733

www.g-u.com

Securing technology for you

